

连接器的选用

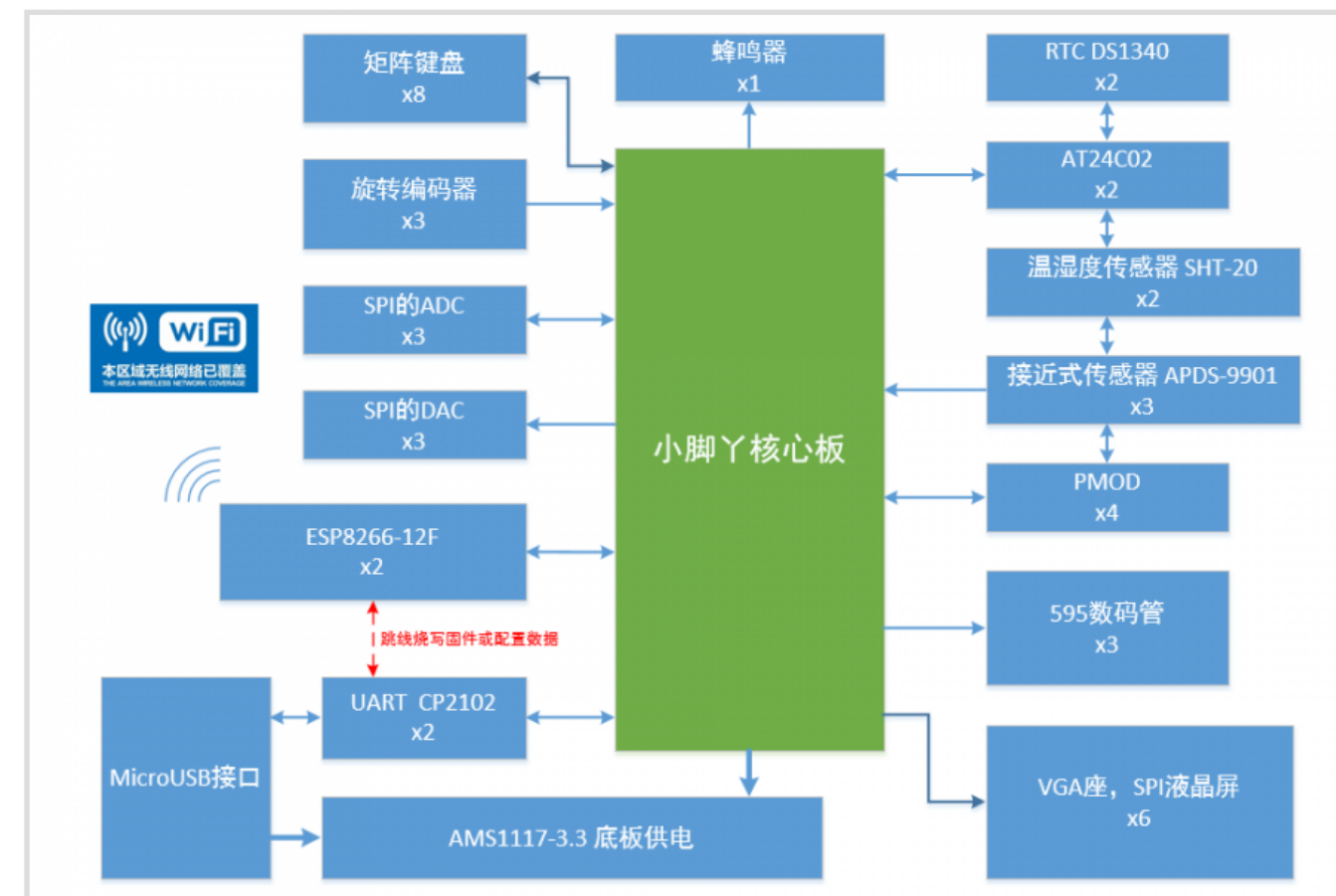
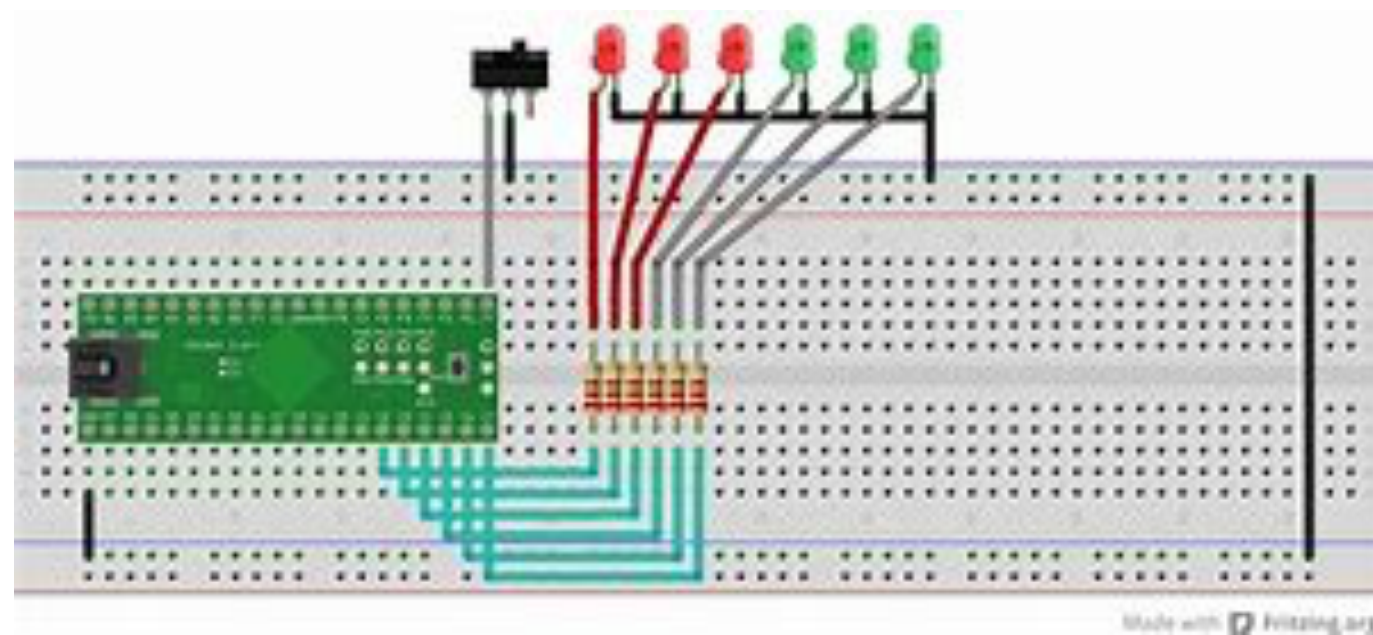
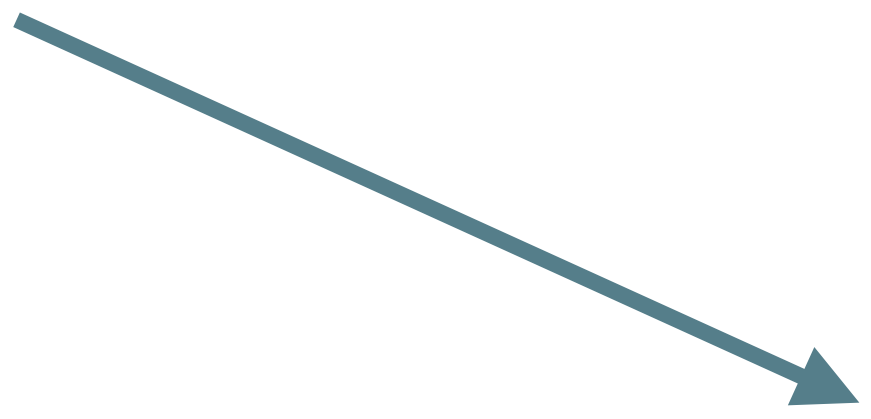
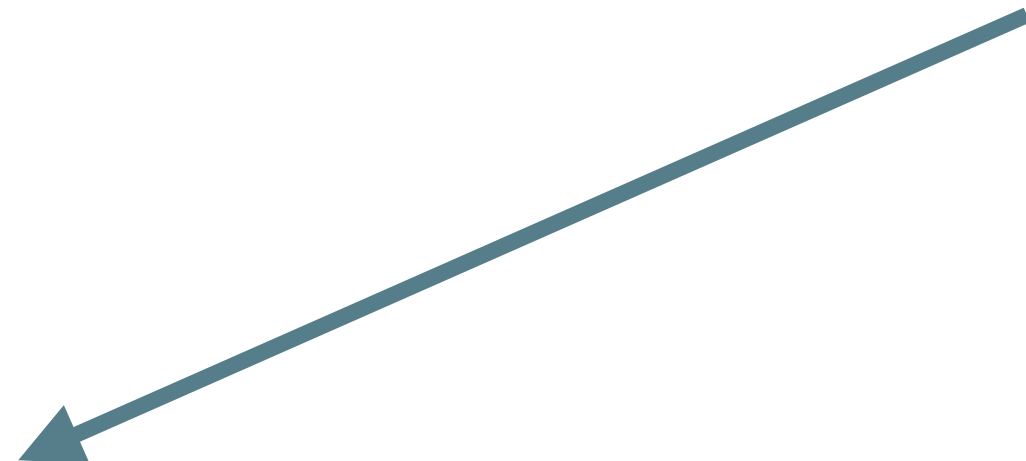
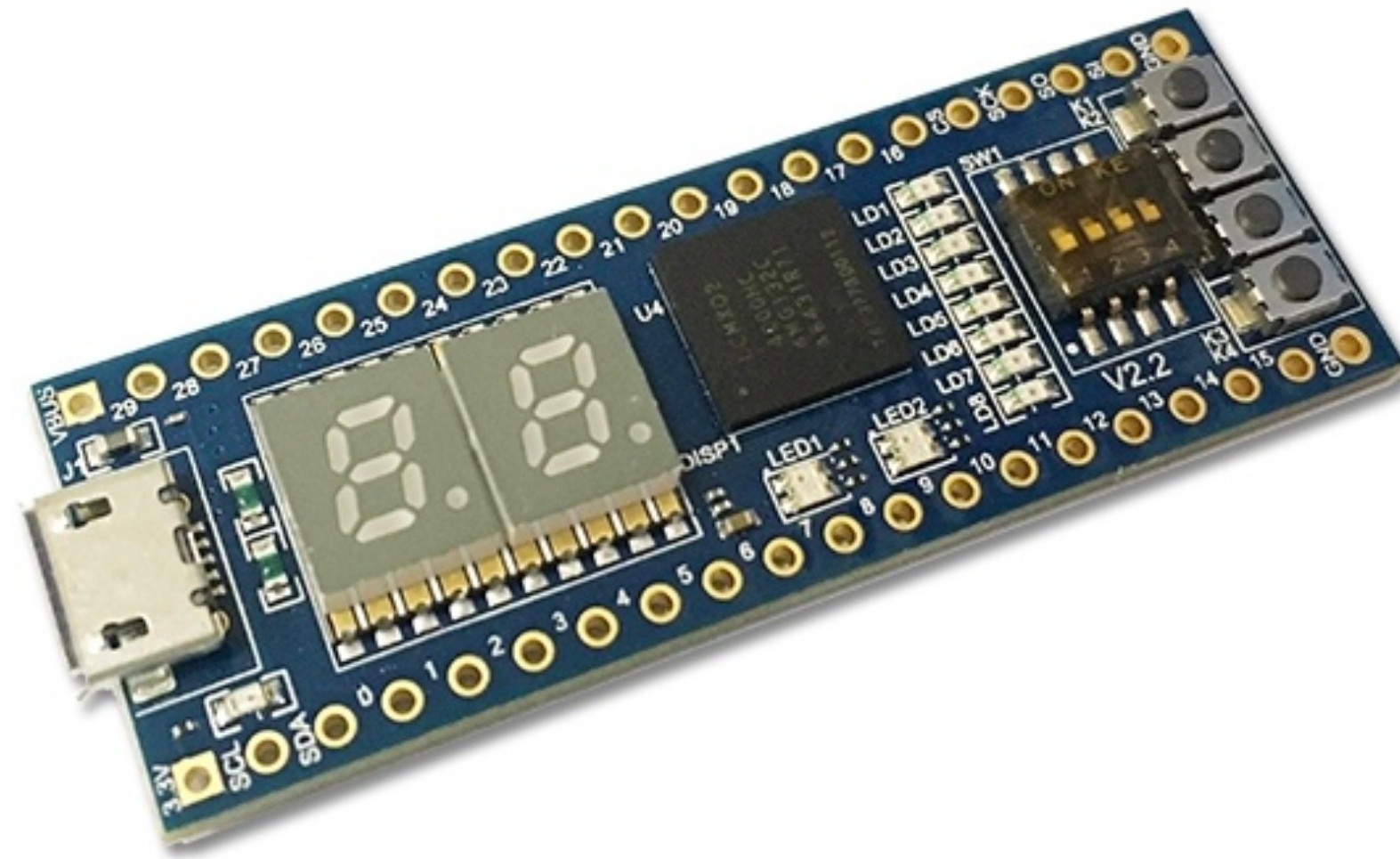

IOT 应用

DDS信号发生器

示波器

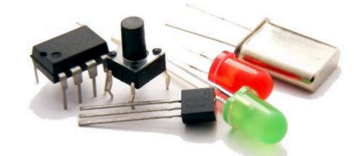

小脚丫生态系统

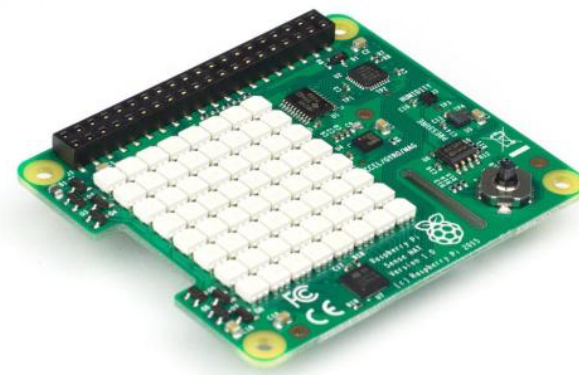
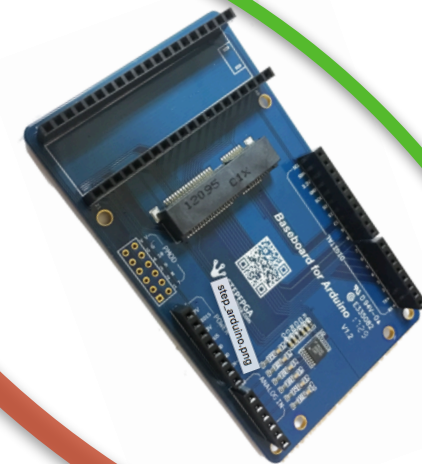
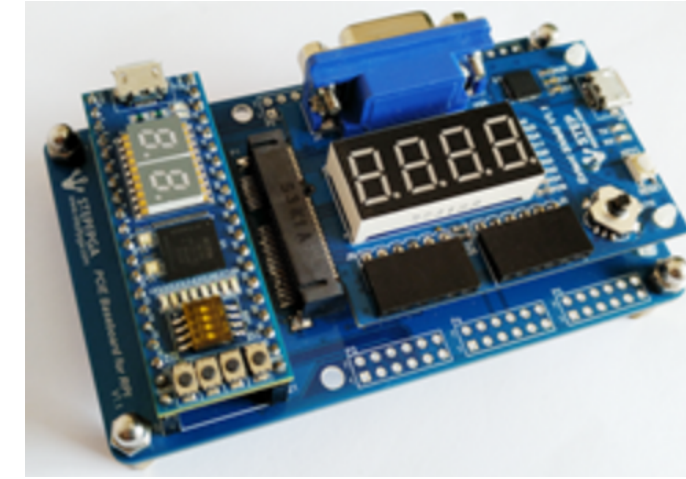
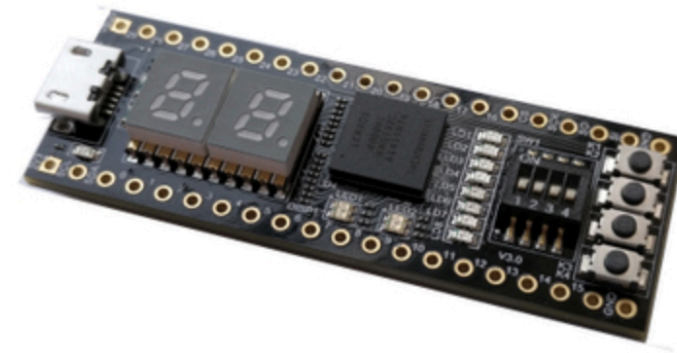

树莓派生态系统

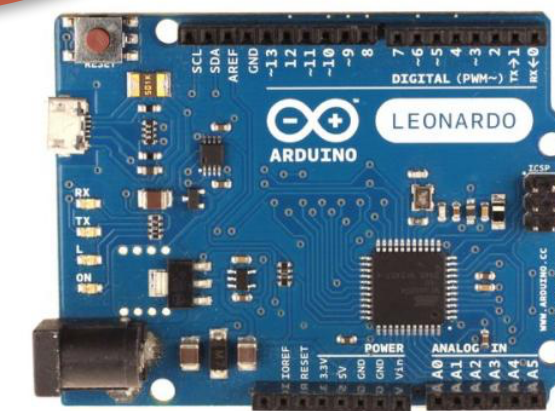
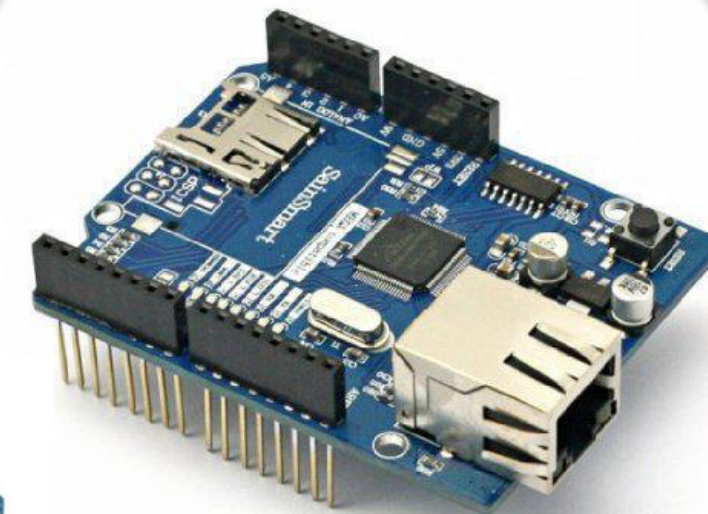

Arduino生态系统

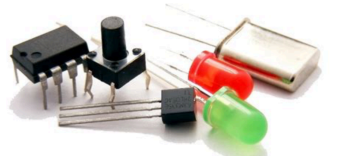

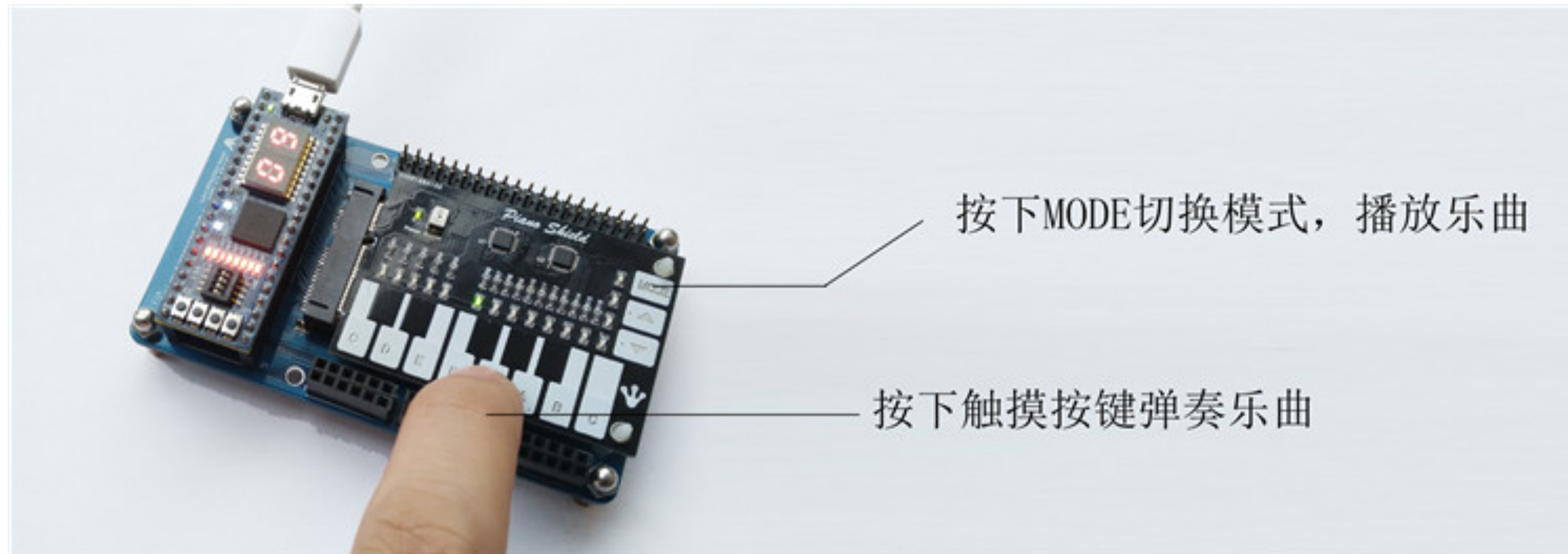
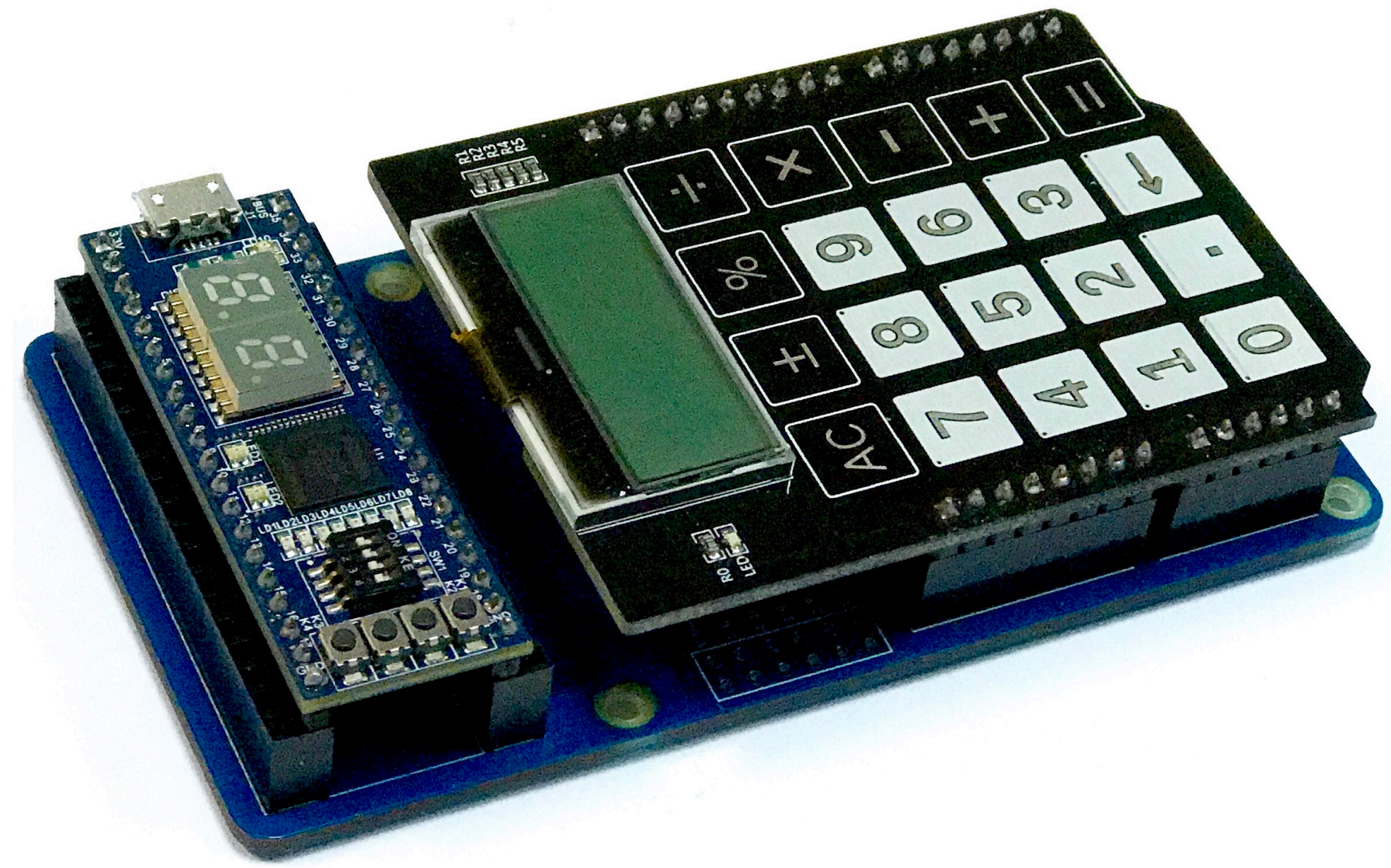
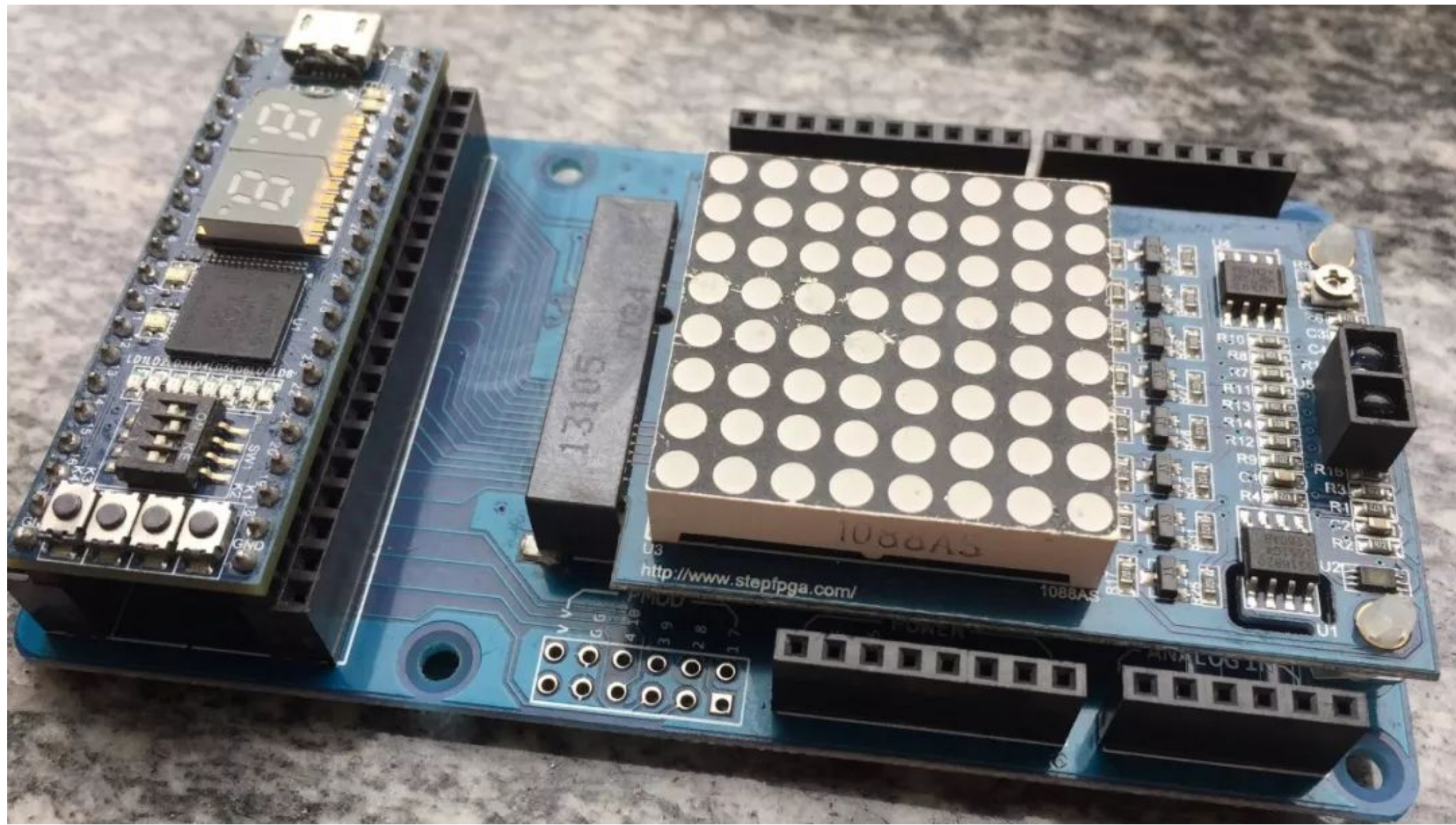

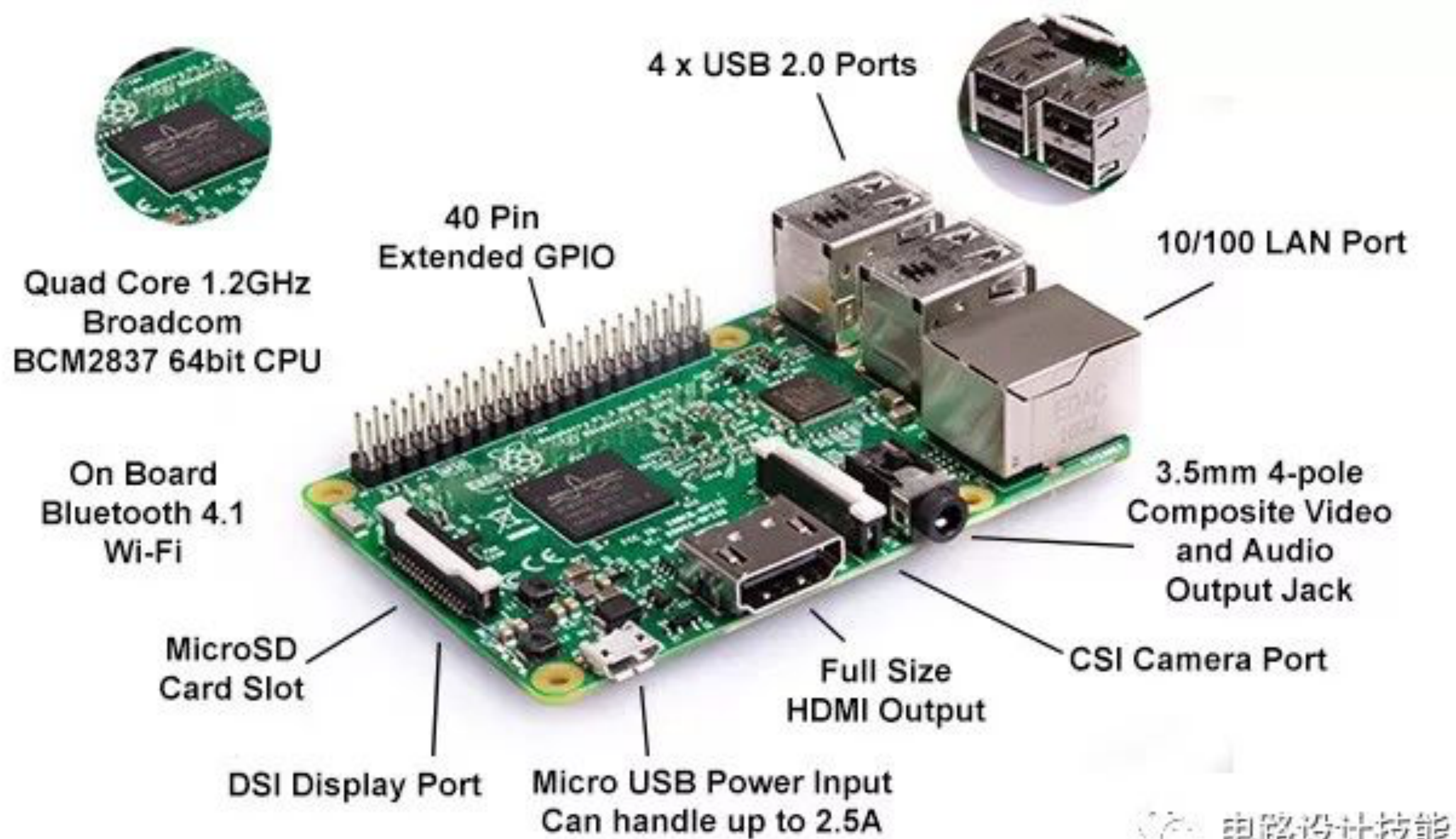

电路设计技能

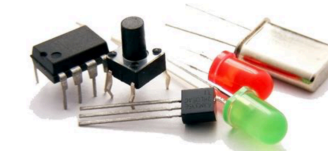



电路设计技能



学技能上 **M** 摩尔吧 **MOORE8** www.moore8.com

买元器件用

M 贸泽电子
MOUSER ELECTRONICS

www.mouser.cn



品类繁多

费时费力

价格不菲

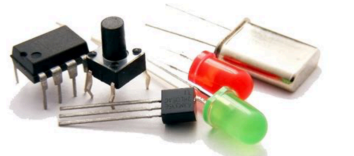

产品类别

最新产品

- LED照明
- 工业自动化
- 工具与供应
- 工程工具
- 无源元件
- 内存和数据存储器
- 电线与电缆
- 电路保护
- 电源

- 半导体
- 机电产品
- 机壳产品
- 光电子产品
- 传感器
- 连接器**
- 测试与测量
- 热管理产品
- 嵌入式解决方案

查看所有

开发工具中心

查看所有

应用和技术

查看所有

与GRANT IMAHARA携手启动创新

查看主题、视频与文章

MOUSER博客

查看工程师博客

订阅中心

立即注册

为何订阅?

- 先看看最新产品
- 应用与技术见解



连接器

- D-Sub连接器(88981)
- FFC/FPC(18969)
- I/O 连接器(5613)
- IC 与器件插座(42875)
- IEEE 1394连接器(75)
- USB连接器(1930)
- 太阳能连接器/光伏连接器(500)
- 未分类连接器(54)
- 卡缘连接器(14532)
- 电源连接器(55865)
- 存储器连接器(2665)
- 光纤连接器(3790)
- 军用规格/军用类型(641697)
- 汽车连接器(31870)
- 板对板与夹层连接器(105337)
- 背板连接器(29387)
- 音频与视频连接器(6848)
- 圆形连接器(682968)
- 射频互连(31678)
- 接线系统(2131)
- 接线端子(109473)
- 集管和线壳(291333)
- 照明连接器(1168)
- 数据总线元器件(759)
- 模块式连接器/以太网连接器(14684)
- 管脚和插座连接器(5235)
- 端子(21569)

制造商A-Z | 新制造商

导出为EXCEL

半导体	连接器	
电路保护	3M	Johnson / Cinch Connectivity Solutions
电源	AAEON UP	JST Automotive Connectors
光电子产品	AB Connectors / TT Electronics	Keystone Electronics
无源元件	Advantech	Kycon
电线与电缆	AIM-Cambridge / Cinch Connectivity Solutions	Kyocera Electronic Components & Devices
测试与测量	AirBorn	Lambda Power / TDK
热管理产品	ALPS Electric	Ledil
传感器	Altech	LEMO
连接器	Amphenol	LS Research / Laird
机电产品	Amphenol Fiber Systems International	LTW / Amphenol
机壳产品	Amphenol PCD Shenzhen	Lumberg Automation
工具与供应	Anderson Power Products	MEAN WELL
嵌入式解决方案	API Technologies	Midwest Microwave / Cinch Connectivity Solutions
	Applied Motion	MikroElektronika
	Aptiv	Mill-Max
	Aries Electronics	Molex
	Aromat	Mueller Electric
	Astrodyne TDI	Netduino
	Auvidea	Neutrik
	Avago Technologies	NorComp
	AVX	Panasonic
	BEI Sensors / Sensata	Parallax
	Bel	PCD / Amphenol
	Bel Fuse	Phoenix Contact
	Bel Magnetic Solutions	Plessey Semiconductors
	Belden Wire & Cable	Polamco / TE Connectivity

电路设计技能

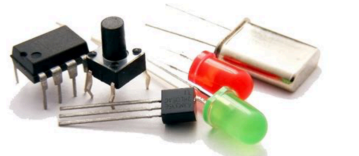



Amazon.com: MUYI 5 Kit 2 Pl... amazon.com



Multipin Design Thermocoupl... omega.com



Sh 1.0 Jst 4-Pin Connector Pl... amazon.com



ELCON Mini Power Connector... te.com



Multi concentric contact connector ... lemo.com



Bakelite Strip Connector at Rs 100 ... indiamart.com

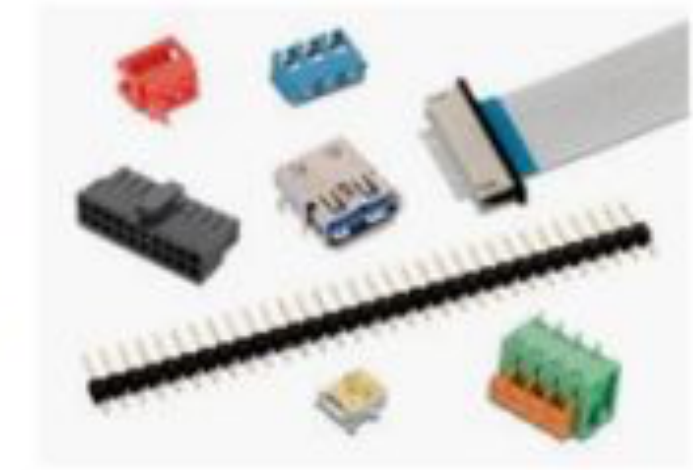

Connectors | Electromechanical Components katalog we-online.de



Power connector for HF Power cor... powerwerx.com



Connectors - Positronic The Science ... connectpositronic.com



Power connector for VHF/UHF Power ... powerwerx.com



Amazon.com: HiLights LE... amazon.com

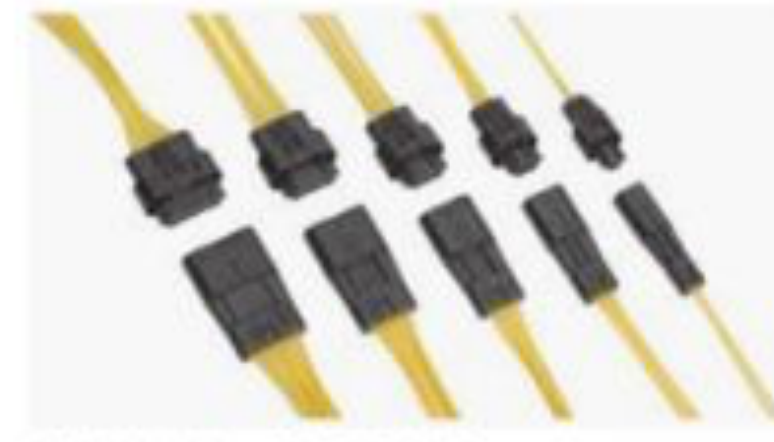

Molex Introduces New Sealed Connector ... molex.com



High Voltage Connector | LEM... lemo.com



Car Motorcycles Waterpro... aliexpress.com



2mm AMP CT Connectors | TE C... te.com



5-Pin JST Quick Connector w/Silicone ... cordlessrenovations.com

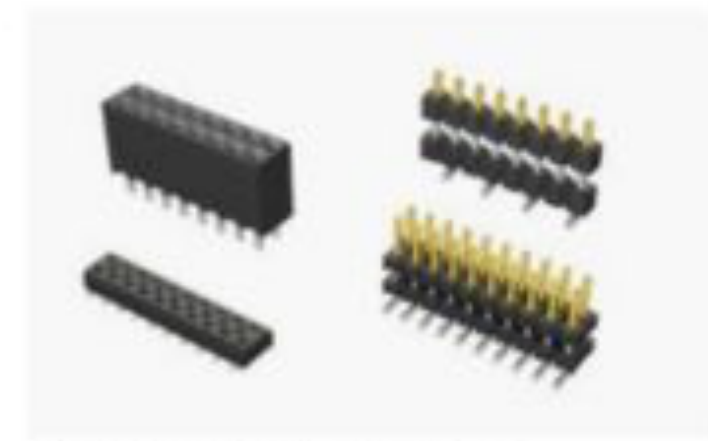

Connectors | Board-to-Board, Arrays ... samtec.com



Ideal RCA Female to Female Co... homedepot.com



expands spring-loaded target connector ... connector-tips.com

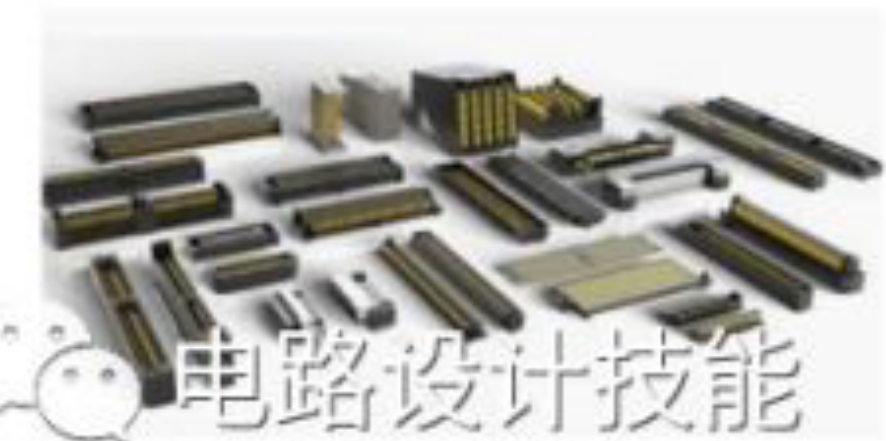

Connector Selection 101 - The Samtec Blog blog.samtec.com

电路设计技能

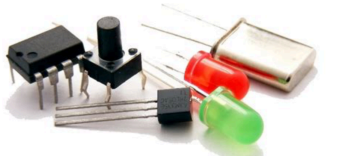

连接器的产业链

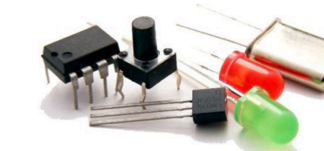
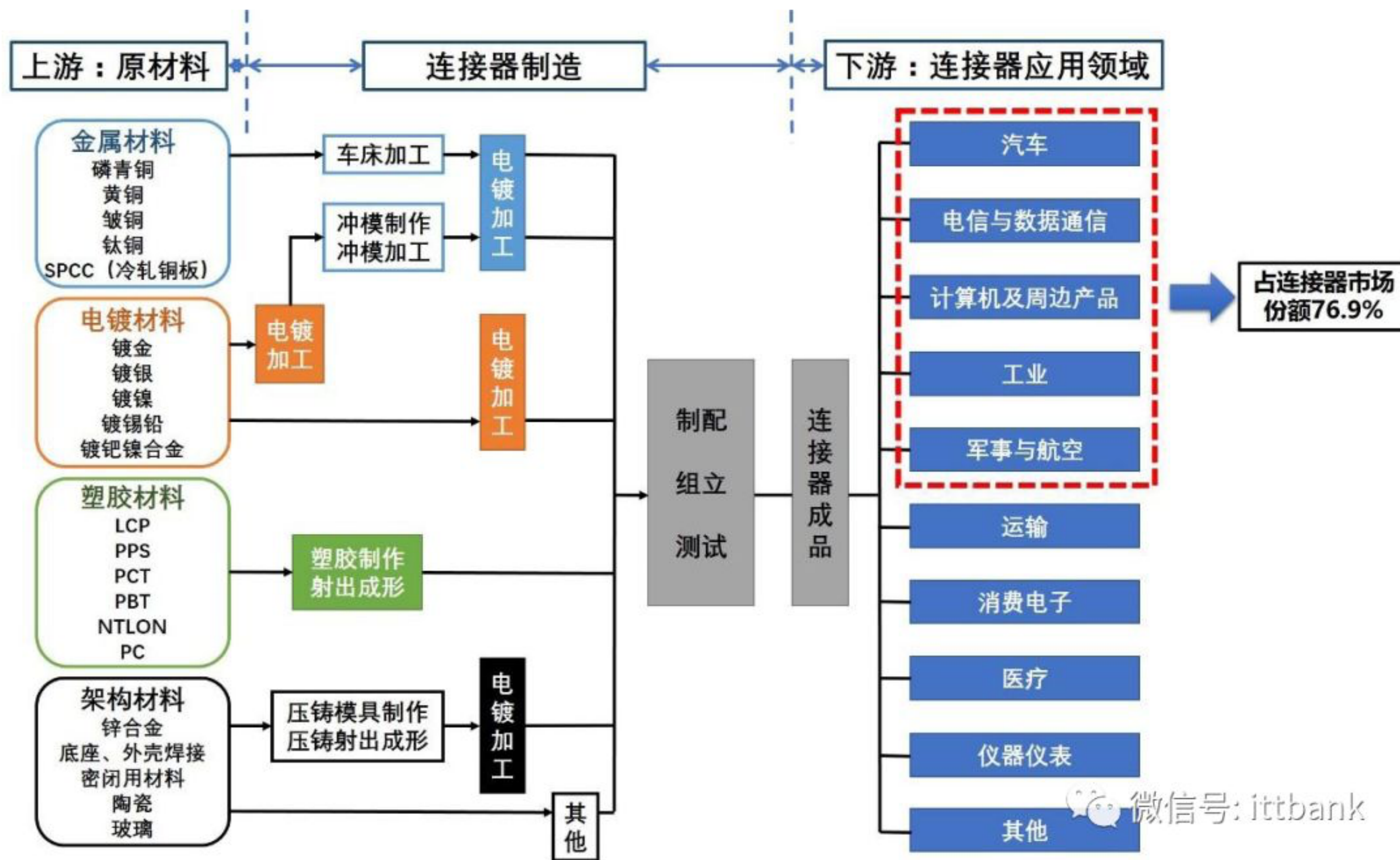

常用连接器分类

条形/压按式连接器 	圆形连接器 	矩形/重载连接器 	射频同轴连接器 	PCB/印刷电路板连接器 
线对线连接器 	FFC/FPC/薄膜电缆连接器 	扁平电缆连接器 	电脑设备连接器 	视频/音频信号连接器 
手机连接器 	电源连接器 	高压连接器 	车用连接器 	航空连接器 
高速信号连接器 	光纤连接器 	微波连接器 	防水连接器 	耐高温连接器 

微信号: ittbank



重点应用

连接器下游	连接器类型	主要产品图示
汽车	传统汽车连接器	
	新能源汽车连接器	
通信	射频同轴连接器	  微信号: itbank
	光纤连接器	

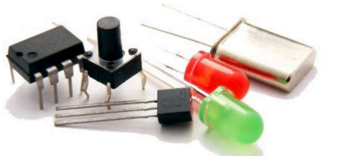

选用原则

- 满足功能的要求 - 连接的对象、信号线的多少和性质
- **成对选用**
- 满足空间的要求 - 管脚间距、高度（PCB设计的3D模型）
- 安装便捷、安装方向识别标示
- 速度要求 - 高速数据通信、RF，屏蔽/接地
- 功率要求 - 大电流
- 可靠性 - 微动、锁住
- 引脚之间的绝缘、坚固性、抗震、耐水
- 价格

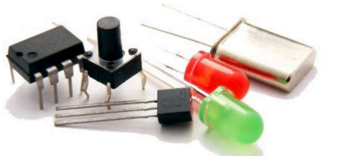

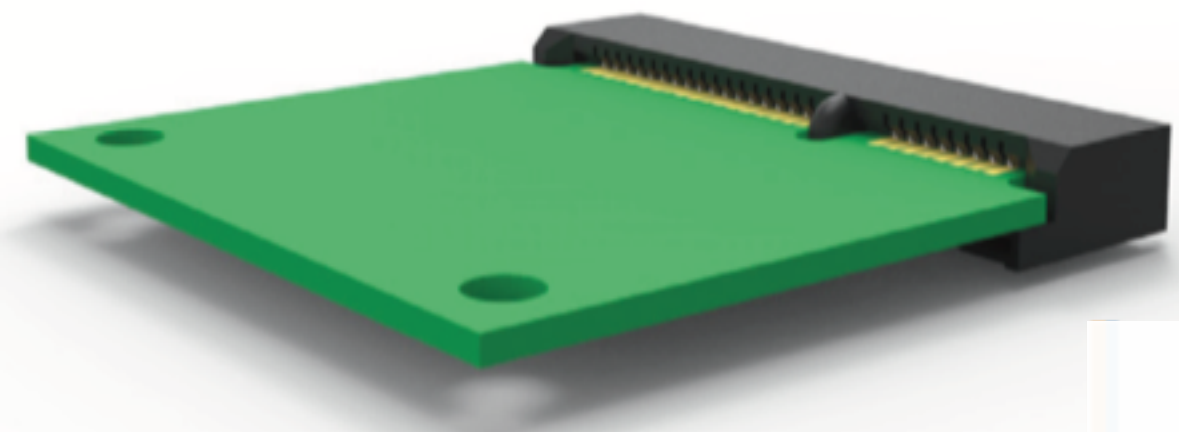
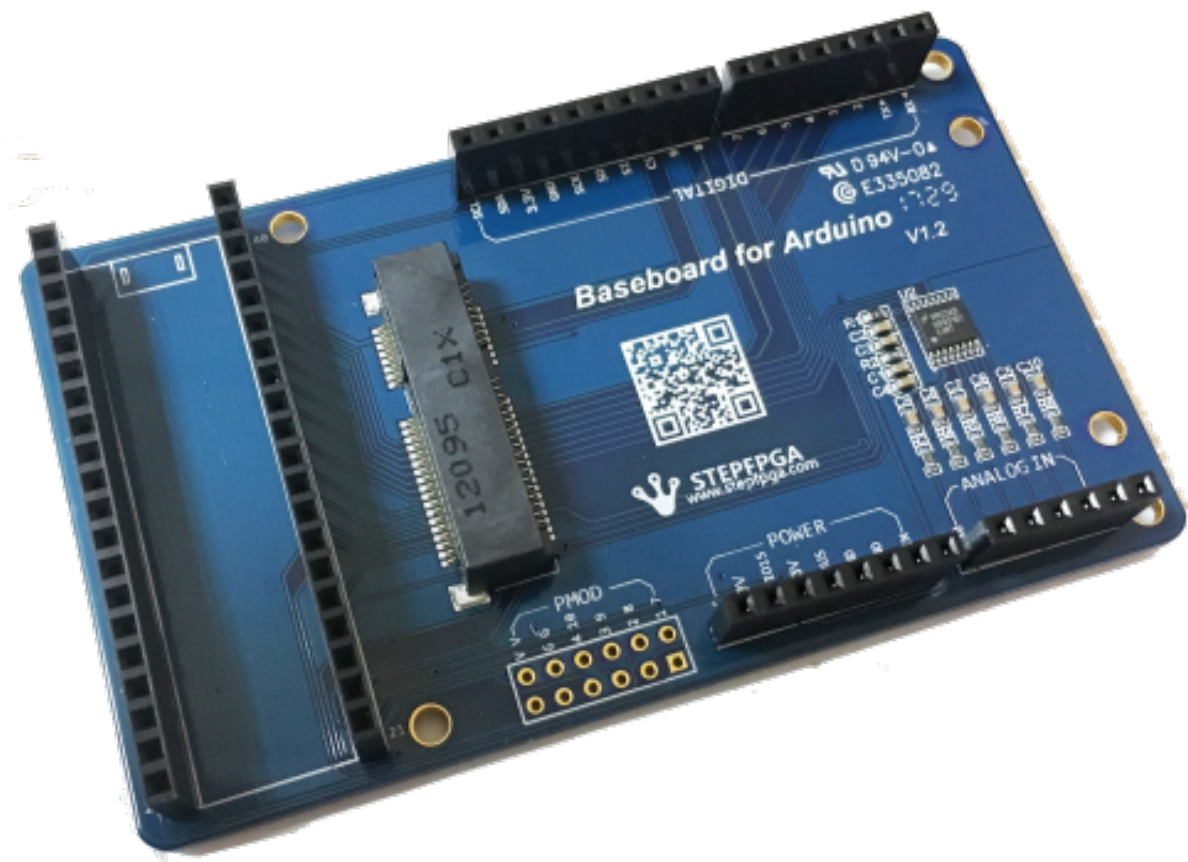

类别 连接器 > 卡缘连接器 > PCI Express / PCI 连接器

可用过滤器 25 个匹配项 6 剩余

启用智能过滤

制造商	产品	位置数量	安装风格	安装角	端接类型	触点材料	触点电镀	系列
--- 最受欢迎 --- TE Connectivity FCI / Amphenol Molex Amphenol --- A到z --- Amphenol	Mini PCI PCI Express	52 Position	Board Lock SMD/SMT	Right Right Angle	SMD/SMT Solder Pin	Brass Copper Alloy Phosphor Bronze Stainless Steel Tin	Gold	48099 67910

应用过滤器

应用过滤器

购买所选商品 对比所选商品 一次最多对比 20 个零件.

选择	图像	Mouser 零件编号	制造商零件编号	制造商	描述	供货情况	单价 (含16%增值税)	数量	RoHS	产品	位置数量	安装风格	安装角	端接类型	触点材料	触点电镀	系列
<input type="checkbox"/>	 扩大	571-1775862-2 要购买完整卷轴, 请订购 550 的倍数:	1775862-2	TE Connectivity	PCI Express / PCI 连接器 mSATA/mini PCI-E 5.2H Type I G/F	数据表 4,249 有库存 更多信息可用	剪切带 1: ¥5.916 10: ¥4.6748 100: ¥4.2108 卷轴 550: ¥3.6656 1,100: ¥3.016 2,200: 查看	<input type="text"/> 最低: 1 倍数: 1 卷轴: 550		Mini PCI	52 Position	SMD/SMT	Right		Copper Alloy	Gold	
<input type="checkbox"/>	 扩大	571-1775838-2 要购买完整卷轴, 请订购 500 的倍数:	1775838-2	TE Connectivity	PCI Express / PCI 连接器 mSATA/mini PCI-E 5.6H Type I G/F	数据表 10,368 有库存	剪切带 1: ¥6.6236 10: ¥6.2292 25: ¥4.9764 100: ¥4.7676 卷轴 500: ¥3.77 1,000: 查看	<input type="text"/> 最低: 1 倍数: 1 卷轴: 500		Mini PCI	52 Position	SMD/SMT	Right		Copper Alloy	Gold	

电路设计技能

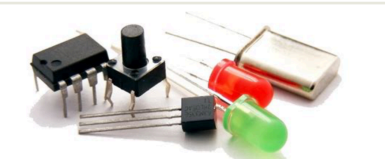

积累知识

- 展会 - 看实物、看图片
- 制造商网站 - 看参数、看文章
- 别人的参考设计 - 拍照片、查BOM



主要厂商

- **TE Connectivity** - www.te.com
- **Amphenol** - www.amphenol.com
- **Molex** - www.molex.com
- **Samtec** - www.samtec.com
- **Hirose** - www.hirose.com

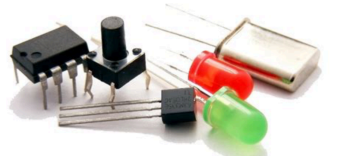

关于贸泽电子 - www.mouser.cn

The screenshot shows the Mouser Electronics website interface. At the top, a blue banner features the slogan '在MOUSER 采购很EASY!' and three key benefits: '数百万产品 一站式购齐', '接受微信支付 付款更简单', and '上海客服 本土支持'. Below this is a navigation bar with the Mouser logo, '联系Mouser (上海) 400-821-6111 | 反馈', and options for '产品', '制造商', '更多', '订单历史', '登录', '注册', and a shopping cart icon. A search bar is located below the navigation bar, with filters for '全部', '物料编号/关键字', '有库存', and 'RoHS'. The main content area includes a '产品类别' sidebar with categories like 'LED照明', '工业自动化', '工具与供应', '工程工具', '无源元件', '内存和数据存储器', '电线与电缆', '电路保护', and '电源'. The central banner promotes '额满免运费*' (Free shipping when full) with a minimum order amount of 175元 and a QR code for WeChat updates. Below the banner is a '最新产品' (New Products) section featuring logos for Texas Instruments, Infineon, Intel, and Molex.

- 与非网/摩尔吧多年合作伙伴
- 全球领先的电子元器件授权分销商
- 700家原厂/500万现货库存
- 小批量采购，170元免邮费
- 1-2周交货

